



MPX 500 24-Bit Dual Channel Processor

User Guide

Unpacking and Inspection

After unpacking the unit, save all packing materials in case you ever need to ship the unit. Thoroughly inspect the modules and packing materials for signs of damage. Report any damage to the carrier at once; report equipment malfunction to your dealer.

Communications Notice

This equipment has been tested and found to comply with the limits for a Class B digital device, pursuant to Part 15 of the FCC Rules. These limits are designed to provide reasonable protection against harmful interference in a residential installation. This equipment generates, uses and can radiate radio frequency energy and, if not installed and used in accordance with the instructions, may cause harmful interference to radio communications. However, there is no guarantee that interference will not occur in a particular installation. If this equipment does cause harmful interference to radio or television reception, which can be determined by turning the equipment off and on, the user is encouraged to try to correct the interference by one or more of the following measures:

- Reorient or relocate the receiving antenna
- Increase the separation between the equipment and receiver
- Connect the equipment into an outlet on a circuit different from that to which the receiver is connected
- Consult the dealer or an experienced radio/TV technician for help

Le présent appareil numérique de la classe B respecte toutes les exigences du Règlement sur le matériel brouilleur du Canada.

Copyright ©1999, Lexicon Inc.
All Rights Reserved.

Lexicon Part No. 070-14116

Lexicon Inc.
3 Oak Park
Bedford MA 01730-1441
Telephone 781-280-0300
Fax 781-280-0490
www.lexicon.com

Table of Contents

Getting Started

- Introduction 1
- Front Panel Overview 2
 - Setting Audio Levels
- Rear Panel Connections 4
 - Audio Connections • Footswitch

Basic Operation

- The MPX 500 Display 7
- Selecting and Loading Programs 8
- Editing 9
 - The "Adjust" Knob • Tap Tempo Functions:
Varying the rhythm • Audio Tap • Setting Tempo
via MIDI
- Bypass 12
- Storing Programs 13

System Mode

- System Mode Parameters 15
 - Bypass • Patching • Program Load • Digital Output
MIDI OUT/THRU • MIDI Pgm Change • MIDI Clock
Receive • Tempo • MIDI Dumps

Program Descriptions

- 1 Plate 22
- 2 Gate 23
- 3 Hall 24
- 4 Chamber 25
- 5 Ambience 26
- 6 Rooms 27
- 7 Tremolo 28
- 8 Rotary 29
- 9 Chorus 30
- 10 Flange 31
- 11 Detune 32
- 12 Pitch 33

- 13 Delay, Echo 34
- About the Dual Programs 36
- 14 Special FX 38
- 15 Flange-Delay 39
- 16 Pitch-Delay 39
- 17 Chorus-Delay 40
- 18 Delay-Reverb 40
- 19 Flange-Reverb 41
- 20 Pitch-Reverb 41
- 21 Chorus-Reverb 42
- 22 MonoSplitDly 43
- 23 MonoSplitRvb 44
- 24 Dual Mono 45

MIDI Operation

- MPX 500 MIDI Behavior 47
- Using Program Change Messages for Program Load... 48
- Learning Continuous Controllers 49
- Activating Bypass or Tap Functions with Program Change
Messages 50
- Clearing a Learned Assignment 51
- MIDI Clock 52
- MIDI Dumps 52
- MIDI Implementation Chart 53

Specifications

Getting Started

Introduction

Thank you for your purchase of the MPX 500 24-Bit Dual Channel Processor.

Powered by Lexicon's proprietary Lexichip™, the MPX 500 has 240 presets with classic reverb programs such as Ambience, Plate, Chamber and Inverse, as well as Tremolo, Rotary, Chorus, Flange, Pitch, Detune, 5.5 second Delay and Echo. Dual-channel processing gives you two independent effects in a variety of configurations: Dual Stereo (Parallel), Cascade, Mono Split and Dual Mono.

A large graphics display and dedicated Edit knobs give you instant access to each preset's parameters and an easy Learn mode allows MIDI patching of front panel controls. In addition, tempo-controlled delays and modulation rates lock to Tap or MIDI clock, and Tap tempos can be controlled by audio input, the front panel Tap button, dual footswitch, external MIDI controller or MIDI Program Change.

Other features include a software-selectable MIDI OUT/THRU port, pushbutton or footswitch selection of dry or muted audio output and a built-in power supply.

To make sure you get the most out of the MPX 500, be sure to read the manual.

Front Panel Overview

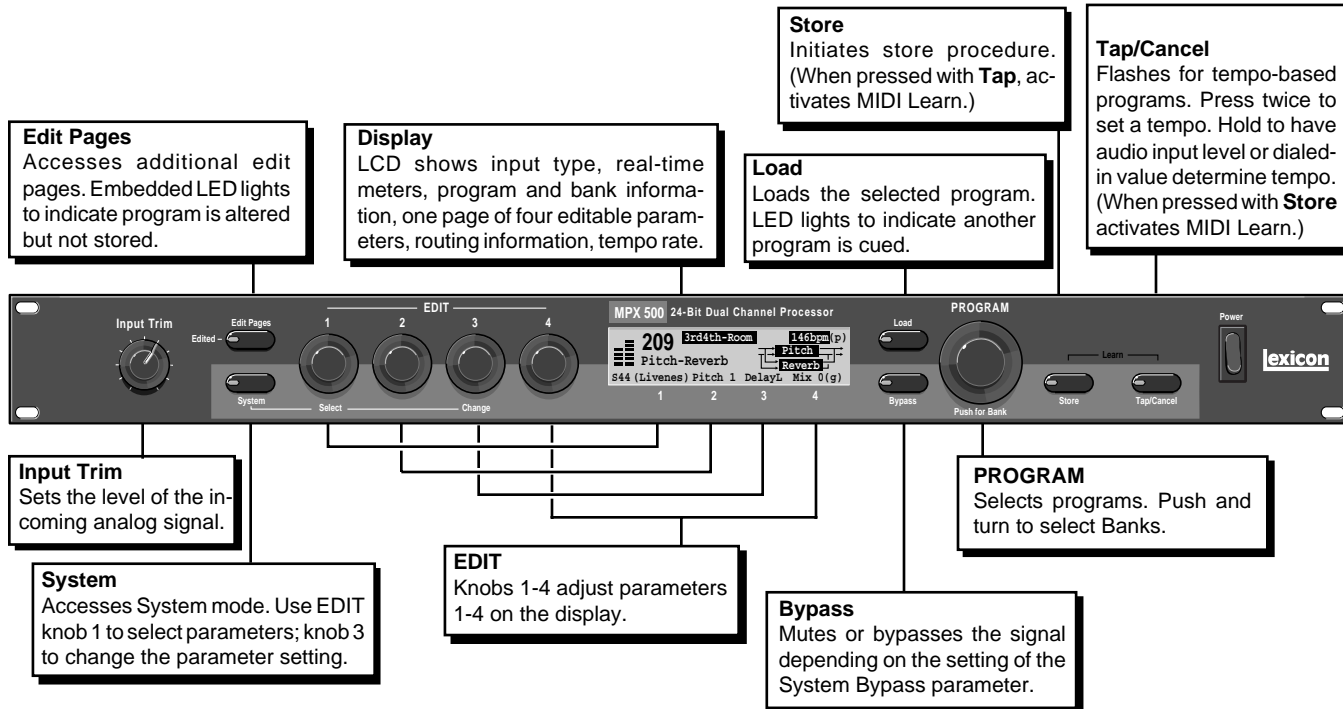

* The level indicators are at their minimum size when the incoming signal is low (more than 30dB below full scale). The highest level indicators are highlighted when the signal approaches full scale.

Setting Audio Levels

As with any audio product, it is good practice to first power on all outboard gear, then the mixer, then any loudspeakers.

Input

1. First, bypass all effects. The System parameter, **Bypass Mode** must be set to pass dry audio. To do this:
Press **System** to enter System mode.
Turn Edit Knob **1** to display **Bypass Mode**.
Turn Edit Knob **3** to select **Dry**.
Press **System** again to exit System mode.
Press **Bypass**.
2. With your highest level program material, start with a very low input level and advance it slowly.
3. When you reach audible distortion, or when the display clip indicators light and stay on, lower the input level until the clip meters come on only on the highest peaks.
The Input Trim control allows the MPX 500 to be driven by an input level in the range of +20dBu to +8dBu. The minimum setting (fully counterclockwise) should be optimal for +4dBu (balanced) inputs. The maximum setting (fully clockwise) should be optimal for -10dBV (unbalanced) inputs.

Output

1. Press **System** to enter System mode.
Output Level (the first System parameter) will be displayed.
2. Turn Edit Knob **3** to set **Output Level**.
0dB should be unity gain for a +4dBu input device.
-12dB should be unity gain for a -10dBV input device.
3. Press **System** again to exit System mode.

Rear Panel Connections

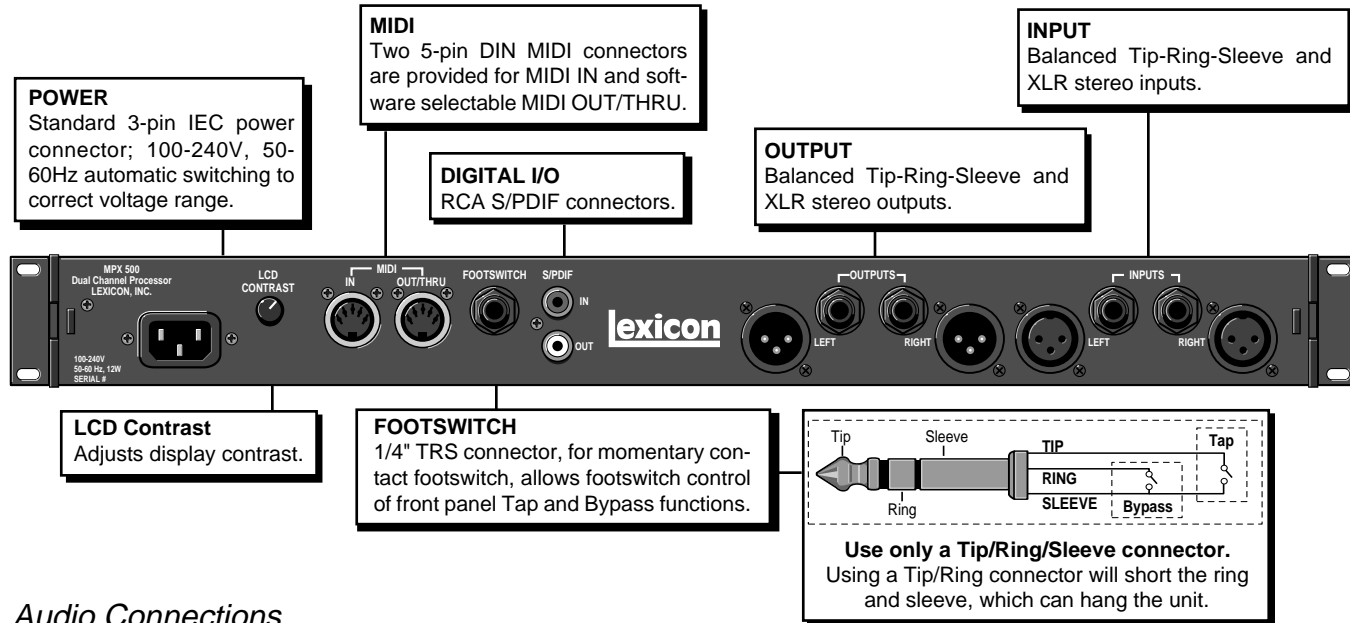

Audio Connections

The MPX 500 produces effects from either mono or stereo sources. With mono sources, the dry signal appears, along with audio effects, at both outputs. For instruments and sources with stereo outputs, use both inputs. We recommend using the outputs in stereo whenever possible, but if mono output is required, use either output jack.

Footswitch

A footswitch connected via the rear-panel footswitch jack allows control of Tap and Bypass. A momentary footswitch can be wired to a tip-ring-sleeve connector. A stereo Y-connector allows two identical single switches to be used.

Power off the MPX 500 before plugging in the footswitch. (Otherwise, Bypass will be enabled.)

The MPX 500 can be used as two independent Effects Processors with the Dual Programs. Designate two auxiliary sends on your console and connect one to the left MPX 500 input, and the other to the right input. Refer to the Program Descriptions to take advantage of this configuration.

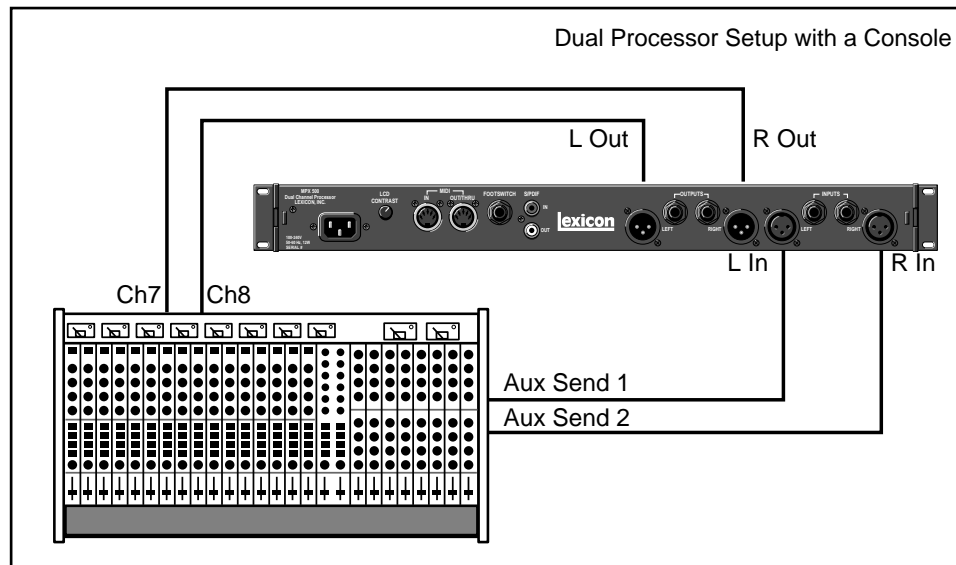
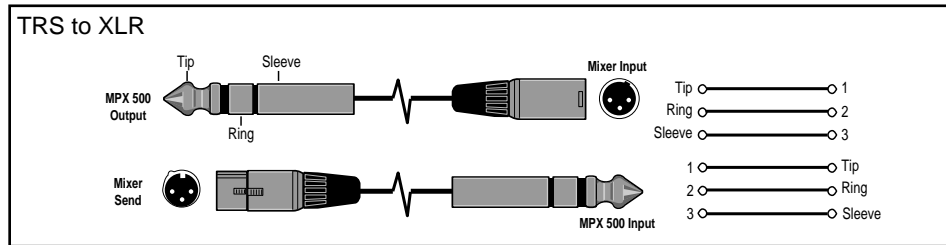

Basic Operation

The MPX 500 Display

The MPX 500 Program Select display shows detailed program information, including routing, the current tempo setting, a full page of as many as four editable parameter settings, and real-time input level meters.

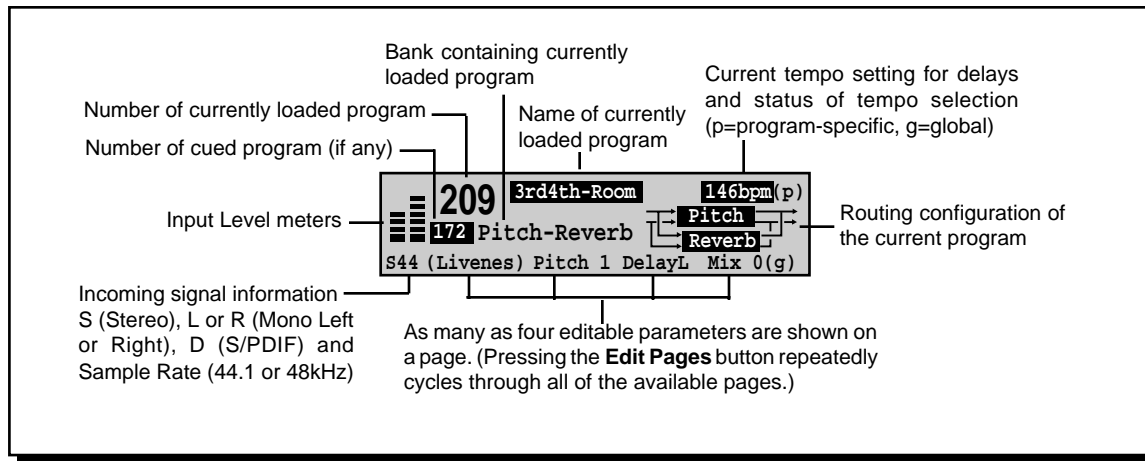

Selecting and Loading Programs

MPX 500 programs are organized into 24 Banks plus a User Bank. (The programs are described in detail later in this manual.) When powered on, the unit will display and load the last program used.

To display any other MPX 500 program, simply turn the front panel PROGRAM knob. The knob will progressively select the rest of the programs in the current Bank, then proceed through each of the remaining Banks. To jump between Banks, push the PROGRAM knob in while turning.

If the selected program is not the currently loaded program, the **Load** LED will light. After four seconds, the display will revert to showing the current program, but the **Load** LED will remain lit to indicate that the last selected program is cued for loading. The number of the cued program will appear highlighted to the left of the name of the current Bank on the display. To load the cued program, press **Load**.

An AutoLoad feature is available which will cause selected programs to load automatically 3/4 second after the knob stops turning. (See *System Mode* for information on activating this and other System mode parameters.)

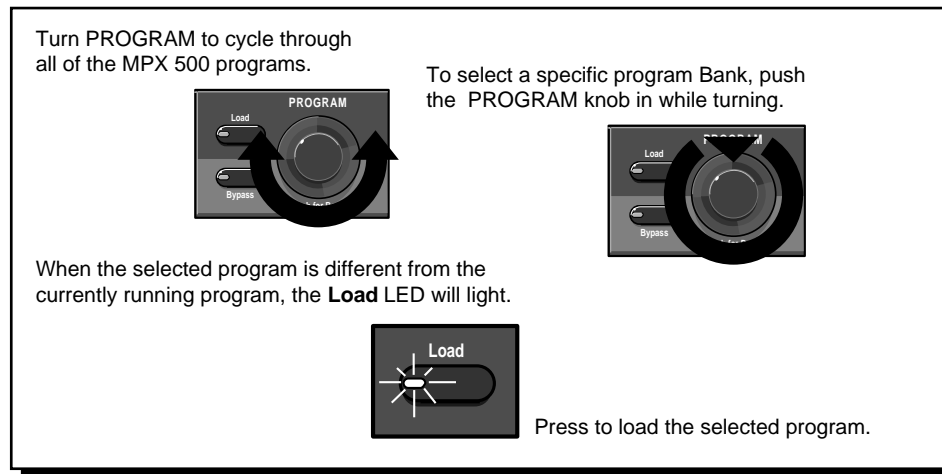

Editing

Each MPX 500 program has as many as 16 editable parameters, organized into edit "pages" of as many as four parameters each. The front panel **Edit Pages** button cycles through all of the available pages for the current program.

Dedicated edit knobs corresponding to each page of displayed parameters make program adjustment easy. Simply turn the knob (1-4) for the displayed parameter (1-4) you want to adjust. When you alter a parameter value, it will be highlighted and the **Edited** LED will light to show that the program is different than the currently running version. (These edit indicators will be turned off when you store the new program, or if you load another program.) If you return to Program Select mode without storing your changes, your edited version will still appear as the currently running program, but the **Load** LED will light and the original version of the program will be cued.

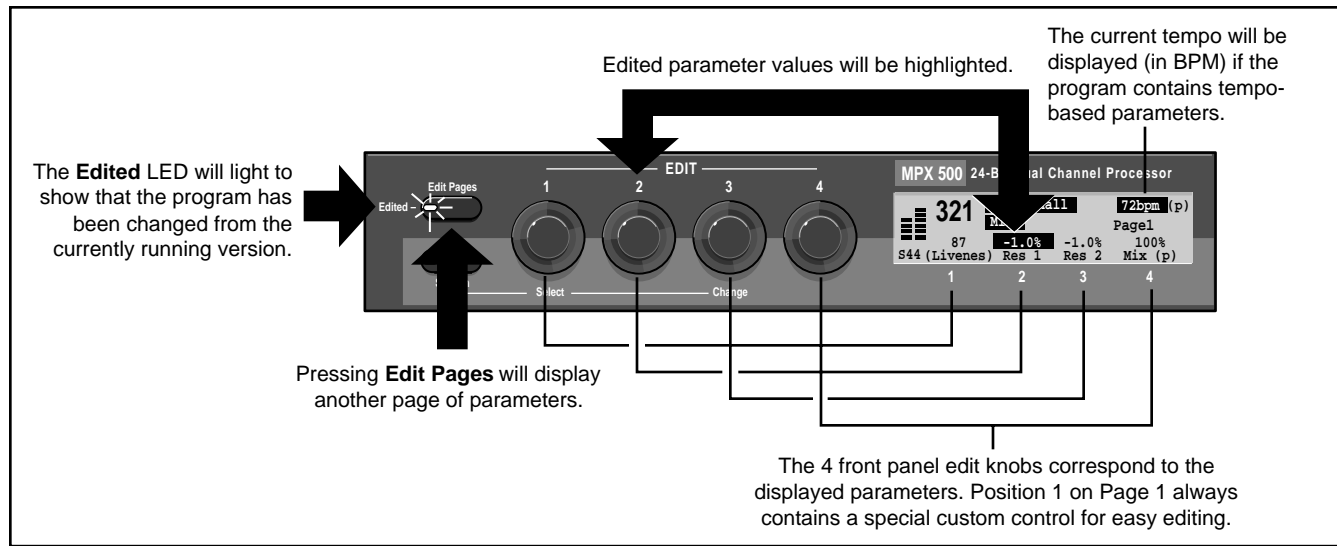

The "Adjust" Knob

A special control in each program lets you make quick adjustments to the most critical parameters of the sound. We have positioned this custom control under Edit knob 1 on Page 1 of each program and refer to it as the **Adjust** knob in this manual.

In many cases, this parameter controls several effect parameters simultaneously to provide simple control of a complex editing process. In many Chamber and Room programs, for example, this parameter controls the "liveness" of the space by changing decay, EQ and early reflections all at the same time. For easy identification, this parameter name will always appear in parentheses, as: **(Liveness)**. When you turn the knob, the bottom display line will temporarily show a more complete description of its function in the running program.

NOTE: As the **Adjust** knob can access and control more internal controls than the 16 displayed parameters in each program, there may be instances where this control (or **Tap**) will modify a parameter which is not displayed on any of the program's edit pages. In these instances, the **Edited** LED will light, even though no displayed parameters are highlighted.

Tap Tempo Functions

Varying the Rhythm

The MPX 500 Tempo features allow you to set the delay times and modulation rates of tempo-based programs to the beat of the music. There are several ways to set tempo (40-400BPM), each of which is described below. No matter which method you select, the current tempo rate will be displayed in the upper right corner of the display, and the embedded LED in the **Tap** button will flash in tempo whenever a program with tempo-controllable parameters is loaded. You can set a global tempo for all of the MPX 500 programs, or have each program stored with its own tempo. (See *System Mode*.) The global (g) or Program (p) system parameter selection is shown to the right of the tempo display.

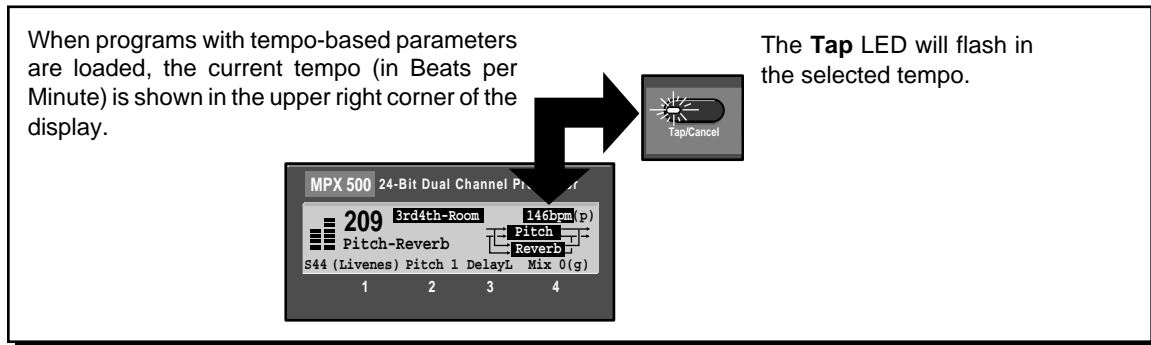

To set the tempo from the front panel, simply press the **Tap** button (or a connected footswitch) twice in time with the music. That's your tempo. No more dialing up what "could be" the delay time in milliseconds — just tap twice — the MPX 500 will figure out the time for you. When you want to change tempo, just tap twice again in the new rhythm.

Audio Tap

You can also use audio input to set the tempo of the MPX 500 delay times.

1. Press and hold the **Tap** button until the Tempo display appears. (Using a footswitch lets you press and hold **Tap** without taking your hands off your instrument.)
2. The message **Detecting Audio** will be shown, along with a list of parameters in the current program which can be controlled by tempo. Play 2 short notes in rhythm to set the tempo.
When you release **Tap**, the message **Use Knob 3** will be displayed to indicate that tempo can now be further adjusted from the front panel. Just turn Edit knob 3 to dial in a tempo (in BPM).
3. Press **Tap** to exit this mode.

Many factory programs are stored with their own tempo rate. You can tap in a new tempo (and store your version in a User location) or set the MPX 500 to always recall the last tempo used and apply it to every program. (See *System Mode* for information on changing the MPX 500 default Tempo Mode from **Global** to **Program**.)

When you select Global Tempo from the MPX 500 System mode, the last tempo tapped in will be applied to all programs with tempo-controlled parameters. (You will know if a program is tempo-controllable because the **Tap** button LED will flash when the program is loaded and the tempo rate display will appear.)

Setting Tempo via MIDI

When used in conjunction with the *Learn* feature, Tap can be set remotely from any MIDI device. MIDI controllers, such as Lexicon's MPX R1 Foot Controller, can be used to send Continuous Controller messages or Program Changes to the MPX 500 or you can send Continuous Controller or Program Change messages from the button and fader moves of many mixing consoles. The MPX 500 will Learn these messages and allow you to set tempo via MIDI.

The MPX 500 can also receive and utilize MIDI Clock. So, when used with a MIDI sequencer or drum machine, the MPX 500 automatically adjusts its internal tempo to match. (See *MIDI Operation*.)

Bypass

Pressing the front panel **Bypass** button will cause the MPX 500 to pass only unprocessed audio, to mute completely, or to mute the inputs to the current effect.

A System Mode parameter determines which of these three options is in effect. (See *System Mode*.) Bypass functions can also be activated by footswitch or via MIDI.

Storing Programs

When you want to save a program, press **Store**. The **Store** and the **Tap/Cancel** LEDs will light to indicate that the MPX 500 store function is armed. (If you want to exit without saving the current program, press **Tap/Cancel at any time before completing the store operation.**)

The first available location in the User Bank will be selected by default when **Store** is pressed. To select a different location (including the location of a User program you want to overwrite), press and turn PROGRAM to select another location in the User Bank.

The program will be displayed with its original name and a numeric suffix (1-9). You can keep this default name, or use Edit knobs 1 and 3 to select character positions and assign characters to create a different name.

Press **Store** to save the program with its new name. When the Store operation is complete, the new program will automatically load (becoming the currently running program).

System Mode

System parameters and MIDI dumps are activated in System mode. To enter this mode, press **System**. The **System** LED will light to indicate you are in System mode.

The adjustable parameters available in this mode are described on the following page. Edit knob 1 will select parameters, edit knob 3 will change the selected parameter's setting.

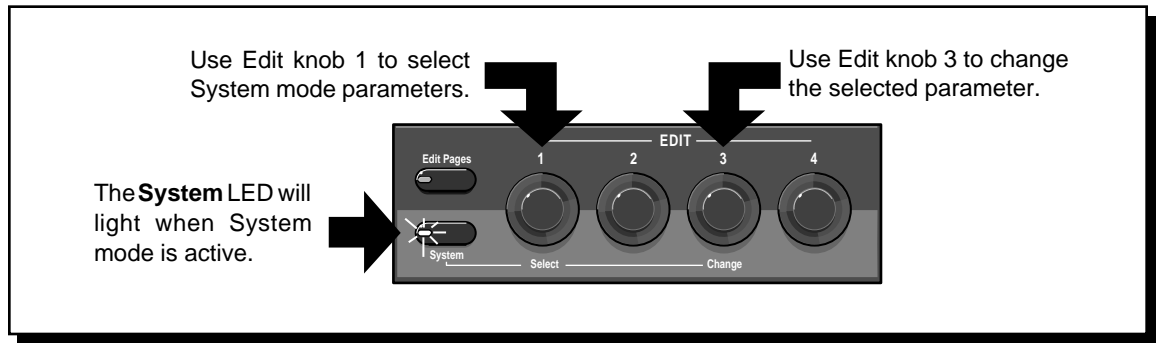

Except for MIDI dumps and reinitialization commands, which require confirmation to execute, system parameter changes are effected immediately.

Pressing **System** again will return the unit to its previous running mode.

System Mode Parameters

Parameter	Settings	Default Setting
Output Level	0dB to -24dB, Off	0dB
Input Source	Analog Stereo, Analog Mono L, Analog Mono R, S/PDIF Digital	Analog Stereo
Clock Source	Internal 44.1K, Internal 48K, External (S/PDIF)	Internal 44.1K
Digital Output	Processed, Dry	Processed
Mix Mode	Program, Global	Global
Bypass Mode	Dry/Full Mute/Input Mute	Dry
Program Load Mode	Bypass Dry, Full Mute	Bypass Dry
Tempo Mode	Program, Global	Global
MIDI Patches	Enabled, Disabled	Enabled
MIDI Channel	Off, 1-16, Omni	1
MIDI Program Change	Enabled, Disabled	Enabled
MIDI Clock	Enabled, Disabled	Enabled
MIDI Out/Thru	Out, Thru	Out
Operating Mode	Normal, Locked, Demo	Normal
Memory Protect	Enabled, Disabled	Disabled
Auto Load	Enabled, Disabled	Disabled
Dump User Bank	-	-
Dump Current Program	-	-
Dump System Data	-	-
Clear User Bank	-	-
Factory Init	-	-

Output Level

This parameter appears by default whenever you press **System** to give you quick access to output level settings.

Input Source

Allows you to specify the type of input. If **S/PDIF Digital** is selected and no digital signal is present, the MPX 500 will mute and display an alert message.

Clock Source

Allows you to select 44.1kHz or 48kHz internal clock sources, or external (S/PDIF) clock source.

Digital Output

When **Dry** is selected, Analog In to Digital Out provides an auxiliary A/D converter.

Mix Mode

Determines whether the current Mix setting of the MPX 500 will be applied to all programs (Global), or whether program-specific Mix levels are restored on each program load.

NOTE: A default Mix value is stored with each program. These individual stored values will take effect when a program is loaded, if Mix Mode is set to **Program** — the Global mix setting will override the individual stored settings if Mix mode is set to **Global**.

Bypass Mode

This parameter sets the **Bypass** button (or the footswitch, or MIDI controller assigned to **Bypass**) to mute the inputs, to mute the inputs and outputs, or to bypass the processed audio (passing only dry audio to the outputs).

Program Load Mode

This parameter determines whether the MPX 500 will engage full mute or simply bypass processed audio while changing programs.

Tempo Mode

Determines whether the current tempo of the MPX 500 will be applied to all programs (Global), or whether program-specific tempos are restored on each program load.

NOTE: A default Tempo is stored with each program. These individual stored tempos will take effect if Tempo Mode is set to **Program** — the Global tempo setting will override the individual stored settings if Tempo mode is set to **Global**.

MIDI Patches

This parameter allows you to temporarily suspend (Disable) and restore (Enable) any Learned patches.

MIDI Channel

Allows selection of a MIDI Channel for all MPX 500 messages (Learned, SysEx and Program Change).

MIDI Program Change

The setting of this parameter determines whether or not the MPX 500 will recognize MIDI Program Change messages for loading programs.

MIDI Clock

The setting of this parameter determines whether or not the MPX 500 will recognize MIDI Clock messages.

MIDI Out-Thru

Sets the rear panel MIDI OUT/THRU jack for either MIDI OUT or MIDI THRU functionality.

NOTE: MIDI Dumps can only be performed when this parameter is set to **MIDI Out**.

Operating Mode

Allows the MPX 500 front panel controls to be locked into their current settings, or to be placed in continuous program load cycle for demonstration purposes.

When **Locked** is selected, only the User Bank is available. Program Load Mode is set to **Auto Load** and only Bypass, Program Select and System modes are available. Edit Mode is not available and Tempo and Patches cannot be Learned.

Changes to this parameter take effect on the next power cycle.

Memory Protect

When enabled, this parameter prevents changes to system parameters and User programs.

Auto Load

When enabled, programs will load approximately 3/4 second after selection. When disabled, **Load** must be pressed to load selected programs.

MIDI Dumps (Dump User Bank, Dump Current Program, Dump System Data)

These selections allow you to execute MIDI Dumps. See *MIDI Operation*.

Clear User Bank

Selecting this parameter will arm a reinitialization procedure that will erase the contents of the User Bank and restore it to its factory state. Pressing **Store** will execute the procedure.

Factory Init

Selecting this parameter will arm a reinitialization procedure that will restore all of the adjustable parameters in the MPX 500 to their factory default states. This includes all User programs, System parameters and Learned patches. Pressing **Store** will execute the procedure.

Program Descriptions

The 240 programs in the MPX 500 are designed to provide a full palette of high caliber ambience, reverb, delay, pitch shift and other effects. As you audition the programs, be sure to vary the **Adjust** parameter.

The **Adjust** parameter (Edit Page 1, Knob 1 in each program) has been carefully customized for each individual program. In many cases it controls several effect parameters simultaneously to provide simple control of a complicated editing process. In many Chamber and Room programs, for example, **Adjust** controls the "liveness" of the space by changing decay, EQ and early reflections all at the same time. This parameter has a range of 0-127 to make it compatible with MIDI control.

For easy identification, this parameter name will always appear in parentheses, as: **(Liveness)**. When you turn the knob, the bottom display line will temporarily show a more complete description of its function in the running program.

The following section provides a general description of each MPX 500 Bank along with tables that detail all of the programs available in that Bank. These details include the function of the **Adjust** parameter and the **Tap** button (for programs that use tempo-controlled rate or delay times).

1 Plate

The Plate programs synthesize the sound of metal plates with high initial diffusion and a relatively bright, colored sound. These programs are designed to be heard as part of the music, mellowing and thickening the initial sound. They are a popular choice for enhancing pop music, particularly percussion.

#	Plate PROGRAMs	Adjust	Tap
1	Small Plate	Livenes	–
2	Medium Plate	Livenes	–
3	Large Plate	Livenes	Predelay (1/32 Note)
4	Tap PreDelay	MidRT	Predelay (1/32 Note)
5	Tape Slap	ips (7.5/15)	–
6	Rich Plate	MidRT	Predelay (1/32 Note)
7	Large &Bright	MidRT	Predelay (1/32 Note)
8	VocalPlate	Livenes	Echo
9	Drum Plate	Livenes	–

Plate reverb was originally generated by a large, thin sheet of metal suspended upright under tension on springs. Transducers attached to the plate transmitted a signal that made the plate vibrate — making sounds broadcast through the plate seem to be occurring in a large open space.

2 Gate

The Gate programs provide a fairly constant sound with no decay until the reverb is cut off abruptly. These programs work well on percussion — particularly on snare and toms, but be sure to experiment with other sound sources as well.

* Note that audio is muted briefly when Time is altered with **Adjust**.

#	Gate PROGRAMs	Adjust	Tap
10	StraightGate	Time*	–
11	Slope Down	Time*	–
12	Drum Gate	HighCut	–
13	140ms TapPre	HighCut	Predelay (1/32 Note)
14	240ms TapPre	HighCut	Predelay (1/32 Note)
15	340ms TapPre	HighCut	Predelay (1/32 Note)
16	440ms TapPre	HighCut	Predelay (1/32 Note)
17	540ms TapPre	HighCut	Predelay (1/32 Note)
18	Inverse	Time*	–
19	Dark Inverse	Time*	–

Gated reverbs were originally created by feeding a reverb, such as a metal plate, through an analog gate device. The decay time was set to instant, and the hold time varied the duration of the sound.

3 Hall

The clean reverberation of the Hall programs is designed to add spaciousness, while leaving the source material unchanged. In addition to general instrumental and vocal applications, the Hall programs are a good choice for giving separately recorded tracks the sense of belonging to the same performance.

#	Hall PROGRAMs	Adjust	Tap
20	Small Hall	MidRT	–
21	Medium Hall	MidRT	–
22	Large Hall	MidRT	–
23	Small Church	MidRT	–
24	Large Church	MidRT	–
25	Jazz Hall	MidRT	–
26	Dance Hall	MidRT	–
27	Synth Hall	MidRT	–
28	Concert Hall	MidRT	–
29	Gothic Hall	MidRT	–

Lexicon's Hall programs recreate the acoustics of actual places, from grand reverberant enclosures to small concert halls.

4 Chamber

The stereo Chamber programs produce even, relatively dimensionless reverberation, with little change in color as the sound decays. The initial diffusion is similar to the Hall programs, but the sense of space and size is much less obvious. This characteristic, along with the low color of the decay tail makes these programs useful on a wide range of material. They are especially useful on spoken voice, giving a noticeable increase in loudness with very low color.

#	Chamber PROGRAMs	Adjust	Tap
30	Brick Wall	HighCut	–
31	Basement	HighCut	–
32	Live Concert	Livenes	Eko Delay
33	Drum Chamber	MidRT	–
34	Moves on...	Livenes	–
35	Live Chamber	Livenes	–
36	VocalChambr1	Livenes	Eko Delay
37	VocalChambr2	Livenes	Eko Delay
38	Wide Chamber	Livenes	–
39	PCM60: Large	MidRT	–

Historically, recording studio chambers were often oddly shaped rooms with a loudspeaker and set of microphones to pick up the ambience in various parts of the room.

5 Ambience

The Ambience programs simulates reflections from room surfaces with random reflections, a gradual decay of overall level, and a gradual narrowing of the bandwidth.

In these programs, the Mix control adds depth — emulating the movement of a coincident pair of microphones from the sound source into the room.

#	Ambience PROGRAMs	Adjust	Tap
40	Announcer	HighCut	–
41	VerySmallAmb	HighCut	–
42	SmallAmb	HighCut	–
43	MidSizeAmb	HighCut	–
44	Studio "D"	HighCut	–
45	Bright Amb	Decay	–
46	Dark Amb	Decay	–
47	Marble Foyer	Livenes	–
48	Smooth Amb	Decay	–
49	Guitar Amb	Decay	–

Ambience gives warmth, spaciousness and depth to a performance without coloring the direct sound, and is commonly used to add a room sound to recorded music or speech. In music recording, Ambience can realistically add distance to close-miked signal.

6 Room

The Room programs are very useful on drums and percussion and can also be applied to electric guitar tracks.





#	Room PROGRAMs	Adjust	Tap
50	Bedroom	Walls	–
51	Tiled Room	LF Boost	–
52	Studio "C"	MidRT	–
53	Small Room	Livenes	–
54	Studio "B"	MidRT	–
55	Rehursal Room	EQ	–
56	Studio "A"	MidRT	–
57	Large Room	EQ	–
58	Fat Space	MidRT	–
59	Chunky Space	EQ	–

The Room programs emulate actual rooms where there is a more apparent sense of being in a small live place.

7 Tremolo

The tremolo programs offer a variety of tremolo shapes (square, sawtooth, triangle, sine and rectified sine). The synchronization of the left and right sides can be adjusted to produce mono and stereo effects. As the tremolo rates of several variations are set with Tap, it's easy to match the tempo of the music. Other variations let you set left and right channel waveforms out-of-phase, resulting in a panning motion.

All of these programs should be used with **Mix** set to fully Wet. By adding more dry to the wet/dry mix, **Mix** effectively sets the depth of the Tremolo. As Tremolo is essentially a rhythmic effect, care should also be taken to make the rate work with the tempo of the music.

#	Tremolo PROGRAMS	Adjust	Tap
60	RectSineTap 	Phase	Rate (1/8 Note)
61	Square Tap 	Phase	Rate (1/8 Note)
62	Sine Tap Trpl 	Phase	Rate (1/8 Note)
63	Triangle 	Phase	Rate (1/8 Note)
64	Sawtooth 	Phase	Rate (1/8 Note)

Tremolo is a rhythmic change in loudness, commonly employed as an expressive technique by vocalists and wind instrument players. It is also one of the oldest electronic effects — frequently used with electric guitar, electric piano and, sometimes, vocals. Different tremolo effects are largely determined by the rate and waveform shape of the loudness change (fast or slow, smooth or sharp). If the effect is used in a stereo mix, the left and right can be synchronized in a variety of ways to produce dramatic side-to-side motion.

8 Rotary

The rotary effect is a detailed simulation of a Leslie-style cabinet. The input signal is split into high and low frequency bands. The rotation effect is created by a synchronized combination of pitch shifting, tremolo and panning. Like the physical model, the high (horn) and low (drum) frequencies are “spun” in opposite directions. Horn and drum speeds are independent, and are designed with acceleration and deceleration characteristics to simulate the inertia of the original mechanical elements.

A virtual requirement for any organ sound, the rotary programs also sound great with guitar and electric piano rhythm parts. In fact, they're great alternatives to chorus and tremolo effects for any sound source.

All of these programs should be used with **Mix** set to fully Wet for the full effect.

#	Rotary PROGRAMs	Adjust	Tap
65	Rot:SlowFast	Switch	–
66	Rot Slow	Resnce	–
67	Rot SpeedAdj	Speed	–
68	Rot TapRate1	Balance	Rate
69	Rot TapRate2	Resnce	Rate

Rotary speaker cabinets were originally designed to provide a majestic vibrato/choir effect for electronic theater and church organs. The most well known rotary speaker is the Leslie™ Model 122, which has two counter-rotating elements — a high frequency horn and a low frequency rotor with slow and fast speeds. The sound generated as the spinning elements change speed is truly magical. The swirling, spacious effect is hard to describe, but is instantly reconizable.

9 Chorus

The stereo Chorus programs uses six independently randomized delay voices panned across the stereo field. These programs, inherited from Lexicon's PCM 80, generate a rich, airy effect that can simulate the sound of multiple sound sources from a single source. These programs are stunning on acoustic or clean electric guitar.

All of these programs should be used with **Mix** set to fully Wet to achieve the full richness of the 6-voice chorus.

#	Chorus PROGRAMs	Adjust	Tap
70	Chorus1	Resnce	–
71	Chorus2	HighCut	–
72	Chorus3	Diffusn	–
73	Slap Chorus1	Diffusn	–
74	Slap Chorus2	Depth	–

Chorus effects multiply the original audio source to create a lush, full sound. Traditionally used to fatten up tracks and to add body to guitar without coloring the original tone, chorus effects are also often used in combination with echoes, plates and other reverb effects.

10 Flange

The MPX 500 stereo Flanger has two 2-tap delays —one per channel. The first tap is fixed, and the second sweeps past it. Mixing the two delay taps together creates the flanging effect.

All of these programs should be used with **Mix** set to fully Wet to achieve the full flange effect.

#	Flange PROGRAMs	Adjust	Tap
75	FIng Lite	Speed	—
76	FIng Lite180	Resnce	—
77	FIng Med180	Speed	—
78	FIng Deep	Resnce	—
79	FIng Deep180	Resnce	—

Flanging effects were originally created by simultaneously recording and playing back two identical programs on two tape recorders, then using hand pressure against the flange of the tape reels to slow down first one machine, then the other. The result was a series of changing phase cancellations and reinforcements, with a characteristic swishing, tunnelling and fading sound.

11 Detune

The 4-voice stereo Detune programs have one pair of voices per channel. As more detune amount is applied (with **Adjust**), the pair grow more out of tune, providing a lush sound without the need for a dry signal to be mixed in.

All of these programs should be used with **Mix** set to fully Wet to achieve the full effect.

#	Detune PROGRAMs	Adjust	Tap
80	Detune Mild	Dtuning	–
81	Detune Med&Warm	Dtuning	–
82	Detune Heavy	Dtuning	–
83	Det Xtreme	Dtuning	–
84	Pitch Detune	Dtuning	–

Detune effects add a delayed/pitch shifted version of the original source — thickening up the sound. They can be particularly effective when used to simulate double-tracking. They are also great alternatives to chorus effects, adding the richness of a chorus without the audible sweep caused by the chorus rate.

12 Pitch

The stereo polyphonic Pitch programs allow complete program material or monophonic sources to be shifted from two octaves down through one octave up.

For pitch correction, use these programs with **Mix** set to fully Wet. For harmonization, use the desired amount of wet/dry **Mix**.

#	Pitch PROGRAMs	Adjust	Tap
85	Pch Chromatic	Pitch	–
86	Pitch Fine	Pitch	–
87	Pch 4th-5ths	Pitch	–
88	Pch PowerInV	Pitch	–
89	Vocal Chorus	HighCut	–

Altering the pitch of a sound allows a variety of effects from subtle detuning to the creation of harmonies and chords.

13 Delay, Echo

The Delay, Echo variations include mono (5.5 seconds), stereo (2.7 seconds) and 6-voice multitap effects. Each of the programs can be used for digital delay *or* tape echo effects. When **the Adjust** parameter (Page 1, Edit knob 1) is set to a value between 63 and 3, tape echo effects are produced. (Each repeat is darker and softer.) When **the Adjust** parameter is set to a value between 64 and 127, digital delay effects are produced. (Each repeat is the same timbre, but softer.)

In programs 90-97, **Adjust** also sets the amount of feedback — with an increasing number of repeats as the parameter value is increased. Delay time is set with **Tap**. Each program is preset with a different useful rhythm.

In Variations 98-104, the amount of feedback is preset and **Adjust** determines Delay time.

NOTE: In all of the Delay programs (including the Dual combinations), Delay times (e.g. **L Dly 1**, **R Dly 1** etc.) not controlled by Tempo, are scaled by the Master Delay parameter (**MstrDly**). In some programs, **Adjust** controls **MstrDly**.

MstrDly values range from 0-100% and are set to 100% in most preset programs. If this control is reset manually (or by **Adjust**) to less than 100%, individual delay times will scale accordingly. For example, if **MstrDly** is set to 25%, delay times will be reduced to 1/4 of their normal value. Other knobs which control those delay times become correspondingly less sensitive — requiring, in this example, 4 times as many clicks to obtain their normal result.

When using any type of delay or echo effects with music, always pay attention to the way the repeats fall rhythmically to the beat. The most effective delay and echo patterns are those that lock in with the tempo of the tune.

#	Delay, Echo PROGRAMs	Adjust	Tap
90	Dly Mono Tap	Feedbk	Delay Time
91	DlyStereo Tap	Feedbk	Delay Time
92	Dly ShufITap	Feedbk	Delay Time
93	Dly Dot8 Tap	Feedbk	Delay Time
94	Dly 8+3pITap	Feedbk	Delay Time
95	Dly Pong Tap	Feedbk	Delay Time
96	Dly XfbkTap1	Feedbk	Delay Time
97	Dly XfbkTap2	Feedbk	Delay Time
98	Dly Mono	Time: 0-5.5sec	–
99	Dly Stereo	Time: 0-2.7sec	–
100	Dly TapeSlap	Time: 3 3/4 to 30ips	–
101	Multi Bounce	Time: 0-100ms	–
102	MultiInverse	Time: 0-400ms	–
103	Multi Linear	Time: 0-400ms	–
104	Multi Pong	Time: 0-150ms + Fbk	–

Delays and echoes are effects that repeat a sound a short time after it first occurs. The simplest (and oldest) delay effect is tape slap — a single repeat about 100ms after the original sound. (It was often used on Elvis’s voice and rockabilly guitar tracks.) Tape slap becomes tape echo when the output of the tape is fed back into the input (feedback), turning a single repeat into a series of repeats — each a little softer and a little darker than the last. This darkening of each repeat is characteristic of the analog tape recording process. Digital delays don’t have this characteristic — each repeat has the same exact timbre and the only difference from repeat to repeat is in loudness.

Digital delay and tape echo are both useful, but they are different. Tape echo is warmer and allows the original sound to stand out more, while digital delay can present a “perfect” copy of the original sound.

About the Dual Programs (Banks 14-24)

The Dual programs combine either a Delay or Reverb algorithm with a Flange, a Pitch or a Chorus. **The Effects Lvl/Bal** parameter (Page 1 Edit knob 3) controls the relative balance of each effect in the combination.

Four routing configurations are used in the Dual programs: Dual Stereo (Parallel), Cascade, Mono Split and Dual Mono.

Bank 14 (Special FX) contains programs which use a variety of routing configurations. The remaining Banks (15-23) are organized as follows:

In Banks 15-21, the first six programs in each Bank are set up in the Parallel configuration - two stereo programs placed side by side so that they receive and output stereo audio from both left and right channels. The last four programs in each Bank are set up in the Cascade configuration - two stereo programs, one placed after the other (for example, Flange-Delay, Flange passes its stereo signal to the Delay).

Banks 22 and 23 are set up in the Mono Split configuration which is similar to Parallel, but here, one program (Flange) receives audio from the left input and the other program (Delay) receives audio from the right input. Both programs then output stereo audio.

Because Dual Mono programs are mixed differently, we've grouped them all in the last preset Bank (24). In these programs, one program (Flange) appears on the left channel only and the other program (Delay) appears on the right channel only.

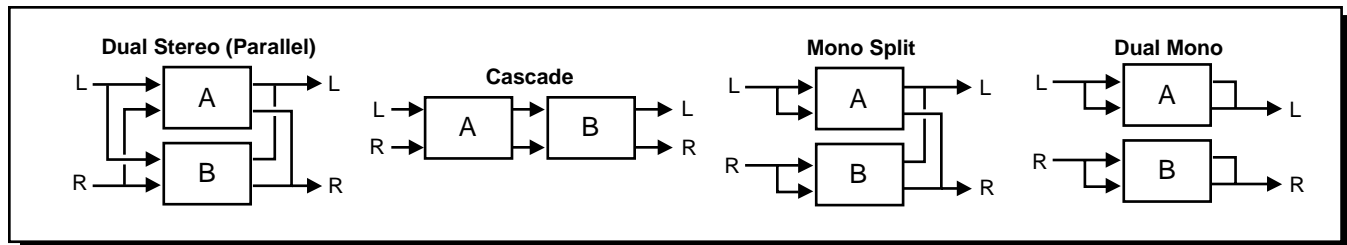

Generally, the **Effects Lvl/Bal** parameter (Page 1, Edit knob 3) controls the balance of the two effects in each dual program. In the cascade variations, rather than simply controlling balance, the knob varies the amount of the first effect or dry signal which is fed into the second effect.

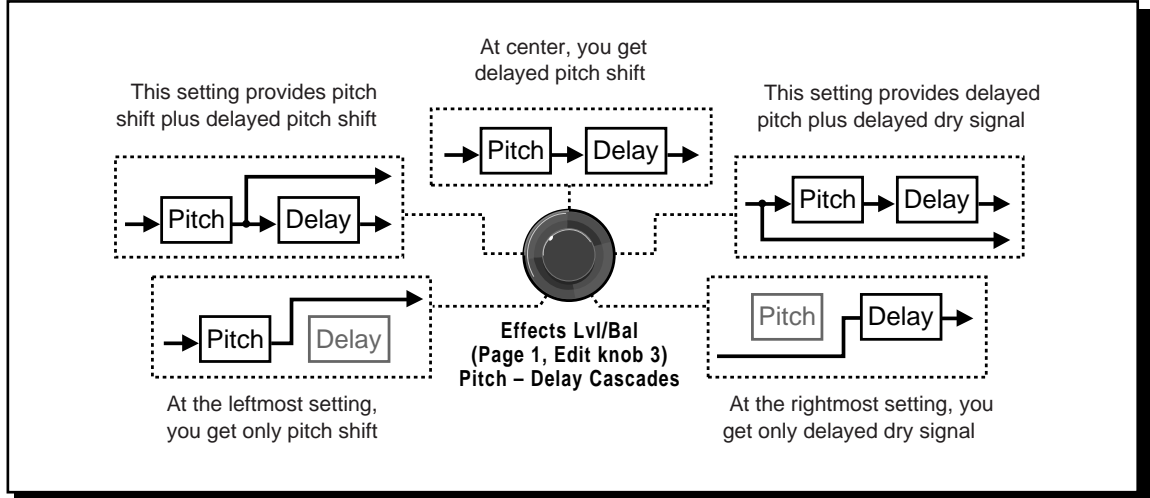

*Behavior of **Effects Lvl/Bal** in the cascade programs. Several points from the knob's continuous range are illustrated here, using Pitch-Delay as an example.*

14 Special FX

The Special FX programs showcase the flexibility and creative possibilities of the MPX 500. **Adjust** is completely different in each of the programs, so be sure to experiment with all of them.

#	Special FX PROGRAMs	Adjust	Tap
105	Infinite	HighCut	Eko
106	The Abyss	Dtuning	–
107	Jet Flange	Resnce	Speed (Whole Note)
108	Chorus>Verb	HighCut	–
109	TapRot Dly	Time: 0-150ms+Fbk	Rate (Drum/Horn)
110	Fader Verb	Level	Echo
111	LowRumble	Decay	–
112	Ducker Verb	Decay	–
113	DuckerChorus	Resnce	–
114	Ducker Xfeed	Feedbk	–
115	Echoes:Beats	Delay	Delay Time
116	Panning Dlys	Feedbk	Dly Time, Pan Rate
117	DreamSequence	Pitch	–
118	Infinite Dly	Feedbk	Delay Time (Whole Note)
119	Diffusor	Diffusn	–

15 Flange – Delay

#	Flange-Delay PROGRAMs	Adjust	Tap	Routing
120	Fling Tap	Feedbk	Delay Time (1/4 Note)	<p>A routing diagram showing two parallel signal paths. The top path contains a 'Flange' block, and the bottom path contains a 'Delay' block. Both paths receive input from the left (L) and right (R) channels and output to the left (L) and right (R) channels.</p>
121	Fling .8Tap	Feedbk	Dotted 1/8 Note	
122	Fling 3plTap	Feedbk	1/8 Note Triplet	
123	Fling PongTap	Feedbk	Delay Time (1/4 Note)	
124	Fling Xfeed	Time: 0-150ms	—	
125	Fling Bounce	Time: 0-200ms, Feedbk	—	
126	Fling>Tap	Feedbk	Delay Time (1/4 Note)	<p>A routing diagram showing two serial signal paths. The top path contains a 'Flange' block followed by a 'Delay' block. Both paths receive input from the left (L) and right (R) channels and output to the left (L) and right (R) channels.</p>
127	Fngl>Fbk	Time: 0-150ms, Feedbk	—	
128	Fng>Pong	Feedbk	Delay Time (1/4 Note)	
129	Fng>Bnce	Time: 0-200ms, Feedbk	—	

16 Pitch – Delay

#	Pitch-Delay PROGRAMs	Adjust	Tap	Routing
130	5th Tap	Pitch	Delay Time	<p>A routing diagram showing two parallel signal paths. The top path contains a 'Pitch' block, and the bottom path contains a 'Delay' block. Both paths receive input from the left (L) and right (R) channels and output to the left (L) and right (R) channels.</p>
131	8ve 3pTap	Pitch	Delay Time	
132	8ve 8+3plTap	Pitch	Delay Time	
133	3rd4thPong	Pitch	Delay Time	
134	4th5th Xfeed	Pitch	Delay Time	
135	5th6th Xfeed	Pitch	Delay Time	
136	8ve> Xfeed	Pitch	Delay Time	<p>A routing diagram showing two serial signal paths. The top path contains a 'Pitch' block followed by a 'Delay' block. Both paths receive input from the left (L) and right (R) channels and output to the left (L) and right (R) channels.</p>
137	5th>Xfeed	Pitch	Delay Time	
138	MajMin>Fbk	Pitch	Delay Time	
139	StepUp>Tap	Pitch	Delay Time	

17 Chorus– Delay

#	Chorus-Delay PROGRAMs	Adjust	Tap	Routing
140	Chor Tap	Feedbk	Delay Time	
141	Chor .8Tap	Feedbk	Delay Time	
142	Chor 8+3pl	Feedbk	Delay Time	
143	Chor Pong	Feedbk	Delay Time	
144	Chor Repeat	Time	–	
145	Chor Bounce	Time	–	
146	Chor>Tap	Feedbk	Delay Time	
147	Chor>Repeat	Time	—	
148	Chor>Pong	Feedbk	Delay Time	
149	Chor>Bnce	Time	–	

18 Delay – Reverb

#	Delay-Reverb PROGRAMs	Adjust	Tap	Routing
150	Tap Small	MidRT	Delay Time	
151	3plTapMidSz	MidRT	Delay Time	
152	8+3pl Large	MidRT	Delay Time	
153	Pong Small	MidRT	Delay Time	
154	Xfeed MidSz	MidRT	Delay Time	
155	Xfeed Large	MidRT	Delay Time	
156	Tap > Room	Livenes	Delay Time	
157	8+3pl> Large	MidRT	Delay Time	
158	Xfeed > Room	Livenes	Delay Time	
159	Xfeed> Large	MidRT	Delay Time	

19 Flange – Reverb

#	Flange-Reverb PROGRAMs	Adjust	Tap	Routing
160	LiteFI Smal	MidRT	Speed (Whole Note)	
161	LiteFI MidSz	MidRT	Speed (Whole Note)	
162	LiteFI Large	MidRT	–	
163	DeepFI Small	MidRT	–	
164	DeepFI MidSz	MidRT	–	
165	DeepFI Large	MidRT	–	
166	LiteFI > Small	MidRT	Speed (Whole Note)	
167	LiteFI > Room	Livenes	Speed (Whole Note)	
168	DeepFI>Large	MidRT	–	
169	DeepFI>Room	Livenes	—	

20 Pitch – Reverb

#	Pitch-Reverb PROGRAMs	Adjust	Tap	Routing
170	3rd4th Room	Pitch	PreDelay (1/32 Note)	
171	4th5th Room	Pitch	PreDelay (1/32 Note)	
172	5th6th Room	Pitch	PreDelay (1/32 Note)	
173	8ve MidSiz	Pitch	PreDelay (1/32 Note)	
174	Power MidSiz	Pitch	PreDelay (1/32 Note)	
175	Detune Room	Dtuning	PreDelay (1/32 Note)	
176	Fine> Small	Pitch	PreDelay (1/32 Note)	
177	Power>Large	MidRT	PreDelay (1/32 Note)	
178	4th > MidSiz	MidRT	PreDelay (1/32 Note)	
179	8ve> MidSiz	MidRT	PreDelay (1/32 Note)	

21 Chorus – Reverb

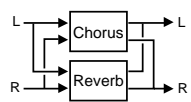
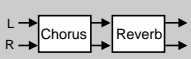
#	Chorus-Reverb PROGRAMs	Adjust	Tap	Routing
180	Chor1 Small	MidRT	–	
181	Chor1 MidSiz	MidRT	–	
182	Chor1 Large	MidRT	–	
183	Chor2 Small	MidRT	–	
184	Chor2 MidSiz	MidRT	–	
185	Chor2 Large	MidRT	–	
186	Chor1 > Room	Livenes	–	
187	Chor2 > Room	Livenes	–	
188	Chor3 > Room	Livenes	–	
189	Chor1 > Small	MidRT	–	

22 MonoSplitDly

#	MonoSplitDly PROGRAMs	Adjust	Tap	Routing
190	Fling+Tap	Feedbk	1/4 Note	
191	Fling+Pong	Feedbk	1/4 Note	
192	Fling+Xfeed	Time	-	
193	Fling+Bnce	Time	-	
194	DeepFI+Dly	Time	-	
195	5th+Tap	Pitch	Delay Time	
196	8ve+3plTap	Pitch	Delay Time	
197	4th5th+Xfeed	Pitch	Delay Time	
198	5th6th+Xfeed	Pitch	Delay Time	
199	PchFine+Tap	Pitch	Delay Time	
200	Chor+Tap	Feedbk	Delay Time	
201	Chor+Pong	Feedbk	Delay Time	
202	Chor+Xfeed	Time	-	
203	Chor+Bnce	Time	-	
204	Chor+Inverse	Time	-	

23 MonoSplitRvb

#	MonoSplitRvb PROGRAMs	Adjust	Tap	Routing
205	Tap+MidSiz	MidRT	Delay Time	
206	Pong+Large	MidRT	Delay Time	
207	Bnce+MidSz	MidRT	Delay Time	
208	Xfeed+Small	MidRT	Delay Time	
209	Xfeed+MidSiz	MidRT	Delay Time	
210	LiteFL+MidSz	MidRT	Speed	
211	LiteFI+Large	MidRT	–	
212	DeepFI+Small	MidRT	–	
213	DeepFI+MidSz	MidRT	–	
214	DeepFI+Room	Livenes	–	
215	4th5th+Room	Pitch	PreDelay 1/32	
216	5th6th+Room	Pitch	PreDelay 1/32	
217	4ths+Large	MidRT	–	
218	8ve+MidSz	MidRT	–	
219	PchFin+MidSz	Pitch	–	
220	Chor1+Small	MidRT	–	
221	Chor1+Large	MidRT	–	
222	Chor2+MidSiz	MidRT	–	
223	Chor2+Large	MidRT	–	
224	Chor3+MidSiz	MidRT	–	

24 Dual Mono

#	Dual Mono PROGRAMS	Adjust	Tap
225	Tap Small	MidRT	Delay Time
226	Tap MidSz	MidRT	Delay Time
227	Tap Large	MidRT	Delay Time
228	Tap Room	Livenes	Delay Time
229	DeepFI Tap	Feedbk	Speed (1/4 Note)
230	DeepFI Dot8	Feedbk	Speed (dotted 1/4 Note)
231	8ves Tap	Pitch	Delay Time
232	8ves 3pl	Pitch	Delay Time
233	Chor2 Tap	Feedbk	Delay Time
234	Chor2 Dot8	Feedbk	Delay Time
235	LiteFI Large	MidRT	Speed
236	DeepFI Large	MidRT	Speed
237	8ves MidSz	MidRT	PreDelay 1/32
238	4ths Large	MidRT	PreDelay 1/32
239	Chor1 Room	Livenes	–
240	Chor2 Room	Livenes	–

MIDI Operation

MPX 500 MIDI Behavior

The MPX 500 “learns” Program Change and Continuous Controllers in its Learn Mode. All of the parameters controlled by the front panel Edit knobs, as well as the **Bypass** and **Tap** buttons are supported.

As all MPX 500 messages use a single, selectable MIDI Channel, before using any of the MIDI control features, you should go to System Mode and select the MIDI Channel you want to use. (See *System Parameters*.)

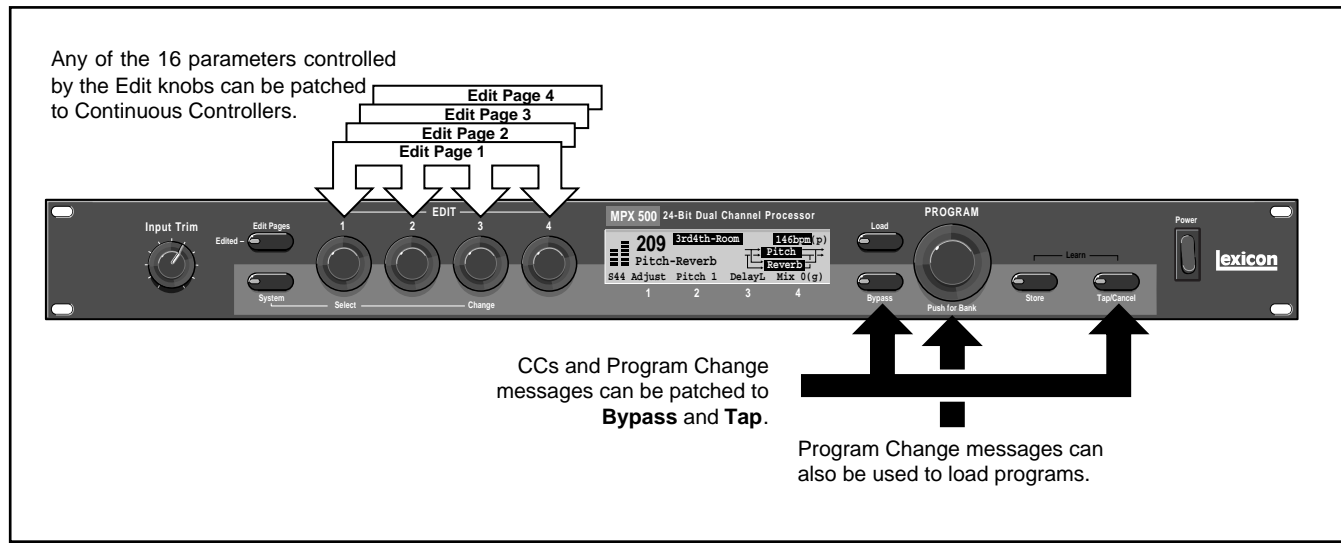

Using Program Change Messages for Program Load

The MPX 500 will allow loading of all of its preset and User programs via standard MIDI Program Change messages. It also conforms to the use of MIDI controller 32 to perform Bank Select. The MPX 500 banks are ordered numerically from 0-24.

Here's how it works. If a standard MIDI Program Change is sent to the MPX 500, Program Change messages 0-9 will load programs the first ten programs from the current Bank.

If a Bank Select message (controller 32) precedes a Program Change message, any of the MPX 500 programs can be loaded.

For example, Program Change 1 with the **Plate Bank selected**, will cause the *Small Plate* program to be loaded. Sending controller 32 with a value of 24 (or higher), followed by Program Change 1, loads the first program of the **User Bank**. Sending controller 32 with a value of 1, then Program Change 2, loads the second program (*Slope Down*) in the **Gate Bank**. Sending controller 32 with a value of 8, then program change 4 will load the last program (*Slap Chorus2*) in the **Chorus Bank**.

Once a bank is selected, all subsequent Program Change messages will select programs within that bank until a new value for controller 32 is received, or until another PROGRAM or BANK selection is made from the front panel.

This function can be disabled with the MIDI Program Change parameter in System Mode.

MPX 500 Program Banks					
0	Plate	9	Flange	18	Flange-Reverb
1	Gate	10	Detune	19	Pitch-Reverb
2	Hall	11	Pitch	20	Chorus-Reverb
3	Chamber	12	Delay/Echo	21	MonoSplitDly
4	Ambience	13	Special FX	22	MonoSplitRvb
5	Rooms	14	Flange-Delay	23	Dual Mono
6	Tremolo	15	Pitch-Delay	24	User
7	Rotary	16	Chorus-Delay		
8	Chorus	17	Delay-Reverb		

Learning Continuous Controllers

The MPX 500 recognizes Pitch Bend, AfterTouch and MIDI Continuous Controllers 1-31 and 33-119. To Learn a Continuous Controller:

1. Simultaneously press **Store** and **Tap/Cancel** to enter Learn Mode. (The LEDs of both these buttons will light to indicate Learn Mode is active.)

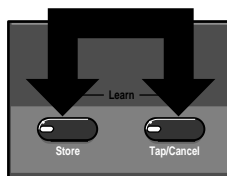

2. Move one of the MPX 500 front panel controls (Edit Knob 1-4 with any of the four edit pages displayed, **Bypass** or **Tap**) to assign it to the controller. (Make sure that the Edit knob you want assigned is displayed before you move its corresponding Edit knob. The selected knob's name will appear highlighted and its current controller number and range will be displayed.)
3. Move the MIDI controller through its full range. To use only a fraction of the controller's range, limit your movement to the desired range. An indicator will appear on the display to indicate incoming MIDI activity.

You can also dial up the controller you want with the Edit knob. In this case, the controller is automatically set to full range (0-127).

4. Press **Store** to commit to the assignment.

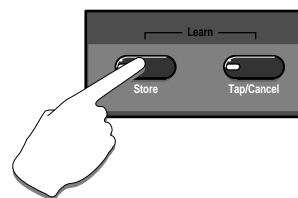

5. To assign another parameter or front panel control to a MIDI controller, repeat steps 2 - 5.
6. Simultaneously press **Store** and **Tap/Cancel** to exit.

NOTE: When a MIDI controller is assigned to Bypass or Tap, moving it through the mid-point of its Learned range will execute a "press" of the front panel button.

Activating Bypass or Tap functions with Program Change Messages

The MPX 500 recognizes MIDI Program Changes 100-127 (101-128 on some MIDI devices) on any channel. To assign a Program Change message to **Bypass** or **Tap**:

1. Simultaneously press **Store** and **Tap/Cancel** to enter Learn Mode. (Both LEDs will light to indicate Learn Mode is active.)

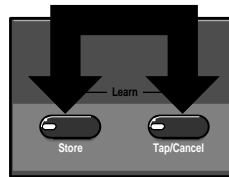

2. Press the front panel button you want to control (**Bypass** or **Tap**).



3. Send a MIDI Program Change to the MPX 500. The display MIDI indicator will come on to indicate incoming MIDI activity.
4. Press **Store** to commit to the assignment.

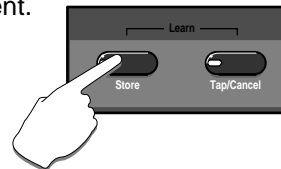

5. Simultaneously press **Store** and **Tap/Cancel** to exit.

To aid MIDI controllers (such as some foot controllers) which do not allow repeated Program Change messages to be sent by a single button, the MPX 500 learns the next highest Program Change along with every Program Change message it learns for **Bypass** and/or **Tap**. For example, if you Learn Program Change 20 as the source for Bypass, Program Change 21 will also control Bypass functions. To avoid conflicting **Bypass** and **Tap** assignments, leave a space between the two buttons' assignments. (i.e. if you learn Program Change 20 for **Bypass**, remember that 21 will also be learned, so you will have to jump to Program Change 22 (and 23) for **Tap**.

Clearing a Learned Assignment

1. Simultaneously press **Store** and **Tap/Cancel** to enter Learn Mode.
2. Turn the front panel control that you want to clear (Edit Knob 1-4 with the assigned parameter displayed), **Bypass** or **Tap**) counterclockwise until **None** is displayed.
3. Press **Store** to execute.
3. Repeat Steps 2 and 3 to clear another front panel assignment.
5. Simultaneously press **Store** and **Tap/Cancel** to exit.

Learnable Front Panel controls and Assignable MIDI Sources

Front Panel Control	MIDI Controllers 1-31, 33-119	MIDI Pgm Change 100-127
Mix	Yes	No
Effects Lvl/Bal	Yes	No
Adjust	Yes	No
Bypass	Yes	Yes
Tap	Yes	Yes

MIDI Clock

The MPX 500 recognizes MIDI Clock messages and applies the tempo (40-400 BPM) to any program which utilizes the Tap-tempo feature. Connect a MIDI device which outputs MIDI Clock (such as the MPX R1 foot controller or a MIDI sequencer) to the MPX 500 MIDI IN jack, to have the MPX 500 automatically recognize and begin to process the MIDI clocks. When you change tempo on the connected device, the MPX 500 will follow along and adjust its delay times or rates to match the tempo.

This can be disabled with the MIDI Clock parameter in System Mode.

MIDI Dumps

MIDI Dumps allow you to back up User programs, the currently running program, or your System Mode settings and Learned patch assignments, to a storage device (typically, a sequencer).

MIDI Dumps are performed in System Mode. To perform a dump of the User programs, the current program, or all of the System Mode parameter settings:

1. Press **System**. The LED will light to indicate you are in System Mode.
2. Turn Edit Knob 1 to select:
 - Dump User Programs
 - Dump Current Program
 - Dump System settings and Learned patch assignments
3. Press **Store** to execute the selected dump.
4. Press **System** again to exit System Mode.

NOTE: Dumps will not be executed unless the System parameter MIDI Out/Thru is set to Out (the default setting.)

MIDI Implementation

Lexicon MPX 500

Function		Transmitted	Recognized	Remarks
Basic Channel	Default	X	1	Selected in System Mode
	Channel	X	1-16	
Mode	Default	X	Mode 2	
	Messages Altered		X	
Note Number	True Voice	X	X	
Velocity	Note ON	X	X (Off=9n v=0)	
	Note OFF	X	X	
After Touch	Keys	X	X	Used as controller Selected in System Mode
	Channels	X	OX	
Pitch Bender		X	OX	used as controller, Learned
Control Change		X	OX	1-119 (0 and 32 used as Bank Select) Learned
Program Change	True #	X	0-15=1-16	100-127 ignored; Program message 0-99=Program Change 1-100 for current Program Group as applicable
	Bank Select	X	O	
System Exclusive	Lexicon	O	O	Product ID=20 (decimal) Device ID=MIDI Channel 0-15 = 1-16
	Real-Time	X	X	
	non Real-Time	X	X	
System Common	:Song Pos	X	X	
	:Song Sel	X	X	
	:Tune	X	X	
System Real Time	:Clock	X	O	
	:Commands	X	X	
Aux Messages	:Local ON/OFF	X	X	
	:All Notes OFF	X	X	
	:Active Sense			
	:Reset	X	X	
Notes:				

Mode 1: OMNI ON, POLY
Mode 3: OMNI OFF, POLY

Mode 2: OMNI ON, MONO
Mode 4: OMNI OFF, MONO

O : Yes
X : No OX: Selectable

Specifications

Audio Inputs

Connectors: XLR/TRS balanced
Level: +20 to +8dBu full scale
Impedance: 50K bal.; 25K unbal.
A/D: 24-Bit Sigma Delta,
20Hz-20kHz ± 1 dB
Crosstalk: -96dB @ 1kHz
A/D Dynamic Range: 105dB, typical

Analog Audio Outputs

Connectors: XLR/TRS balanced
Level: +26dBu balanced;
+20dBu unbal.
Impedance: <600 Ω
D/A: 24-Bit Delta Sigma;
20Hz-20kHz ± 1 dB
Crosstalk: -96dB @ 1kHz
D/A Dynamic Range: 101dB, typical

Digital Audio I/O

Connectors: Coaxial RCA;
S/PDIF (IEC-958, CP-340)

System Sample Rates

Internal Clock and S/PDIF Input:
44.1, 48kHz

Display

150 x 32 LCD, Backlit

Footswitch

Tip/Ring/Sleeve phone jack for
Bypass and Tap (optional)

MIDI Interface

Connectors: IN, OUT/THRU

Power Requirements

90-250V 50-60Hz; 12.5W
3-pin IEC Connector

Dimensions

19"W x 1.75"H x 4"D (483x45x102mm)

Weight

3 lbs (1.4kg)

Environment

Operating Temperature: 32°-104°F
(0°-40°C)
Relative Humidity:
95% non-condensing

RFI/ESD

FCC class B; European EMC
Directive 89/336/ECC

Specifications subject to change without notice.